

Elevator Drives, Power Quality and Energy Savings

by Jonathan Bullick and Brad Wilkinson



**Value: 1 contact hour
(0.1 CEU)**

This article is part of ELEVATOR WORLD's Continuing Education program. Elevator-industry personnel required to obtain continuing-education credits can receive one hour of credit by reading the article and completing the assessment examination questions found on page 113. For this article and more continuing-education opportunities, visit www.elevatorbooks.com.



Approved by NAEC



Approved by NAESA
International



Approved by QEI Services, Inc.

Learning Objectives

After reading this article, you should have learned about:

- ◆ The basic components and operation of an elevator VFD and regenerative unit
- ◆ How AC elevator drives create current harmonics
- ◆ How current harmonics create voltage distortion and affect the operation of electrical equipment
- ◆ How current harmonics can be reduced in elevator VFDs
- ◆ The relative cost and performance of various harmonic mitigation and regenerative solutions

Introduction

During the past 25 years, the use of AC variable-frequency drives (VFDs) has grown, and, for many, they have become the preferred way of controlling elevator traction machines. The advantages are well documented and include increased system efficiency, simplified commissioning and improved ride quality. Increasingly, the issue of power quality on the electric system is becoming a point of concern when selecting and sizing elevator systems.

This article begins by explaining the basic building blocks of a VFD and how current harmonics are created. A brief overview of the related IEEE 519-1992^[1] standard as it relates to elevator and building installations is then discussed. Finally, advanced drive architectures with a focus on harmonic performance and energy savings are outlined and a cost/benefit analysis of each technology is provided.

Six-Pulse VFD

The six-pulse VFD is most commonly applied in industrial applications, because it has proven to be cost effective and reliable. A six-pulse VFD (Figure 1) consists of three main sections: the input diode bridge, intermediate DC-bus capacitors and output transistors.

The input stage is made up of a three-phase full-wave diode bridge that rectifies the incoming three-phase AC power into DC power. Since the diodes allow current to pass only in one direction, it should be noted that the input stage of a six-pulse VFD acts as a one-way street – allowing electrical energy to flow into the drive but not back into the line.

The intermediate stage, or “DC bus,” is primarily made up of capacitors. The capacitors filter the voltage ripple

Continued

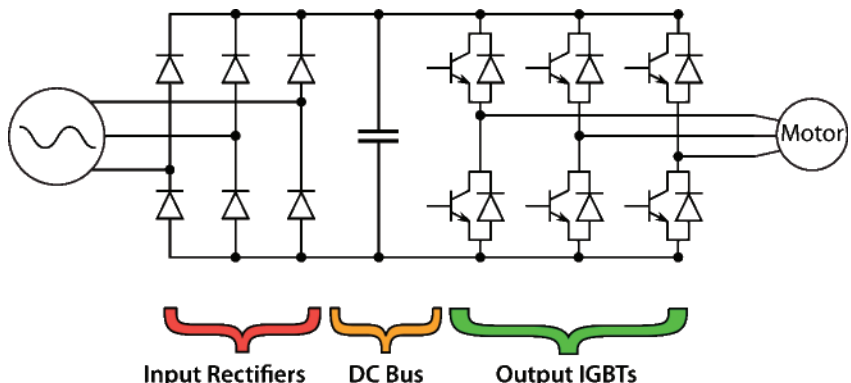

Figure 1



created by the AC/DC conversion and act as a buffer by storing energy.

The output stage of the VFD consists of six insulated-gate bipolar transistors (IGBTs), which turn on and off at a high frequency (usually 8 kHz or greater), thereby modulating the DC voltage from the bus capacitors. The technology is referred to as pulse-width-modulation (PWM) and allows the drive to construct a three-phase variable AC voltage/frequency output to the elevator motor. By controlling the magnitude and phase of the voltage and frequency, the drive is able to control the motor's torque and speed. Unlike the input diodes, current can flow in both directions across the IGBTs, allowing energy to be put back onto the DC bus capacitors.

Linear and Nonlinear Loads

An electrical load is any device to which power is delivered or consumed. One way to classify loads is by the nature of their current draws – linear or nonlinear. During steady-state operation, a linear load's impedance does not change throughout the AC electrical cycle, and it will draw a purely sinusoidal current from an ideal AC voltage source (Figure 2). Examples of linear loads are resistors, capacitors, inductors and AC motors operating in steady state from the AC line.

By contrast, a nonlinear load's impedance does change throughout the AC electrical cycle, and the load draws current irregularly (Figure 3).

Since the irregular current draw is not sinusoidal, it contains harmonics of the fundamental frequency. The current harmonics act on the system impedances within a building's electric power system. As the number and magnitude of the harmonics increases, the voltage available to other loads within the system becomes distorted. Eventually, if the distortion is high enough, the operation of other equipment can be adversely affected (Table 1).

Harmonics Cause	Effect
Increased rms current	Must oversize transformers, fuses, conductors, etc.
Increased rms current	Higher resistive losses in the system
Increased heating in electrical components	Stresses electrical insulation system; contributes to insulation failure
Mechanical oscillations in line-driven rotating equipment	Stresses components, ultimately causing premature failure; increased noise
Higher voltage distortion on the electric system	Interference with the operation of sensitive equipment (i.e., computers, telecommunication devices, etc.)

Table 1: Harmonics are undesirable for both utility companies and users.

In short, higher current harmonics result in a greater rms current draw from the electric system. The increased current means the sourcing equipment (fuses, wires and transformers) of the system must be oversized. Additionally, as the harmonic currents flow through resistive impedances, additional heat is lost.

VFD as a Nonlinear Load

Electronics that use rectifiers or semiconductors as switches during power conversion are all nonlinear loads. A typical building has many nonlinear loads, including fluorescent lights; older uncompensated electric equipment; and VFDs operating elevators or heating, ventilation, and air conditioning (HVAC) systems. When connected to a three-phase power source, a six-pulse rectifier creates two nonlinear current pulses during each half wave of AC voltage (Figure 4).

The current harmonics generated by a VFD are a function of the number of rectifiers used on the input stage of the VFD and can be described by the following equation:

$$h = kq \pm 1$$

where:

h = harmonic order

k = any integer

q = the rectifier pulse number (i.e., 6, 12, 18, etc.)

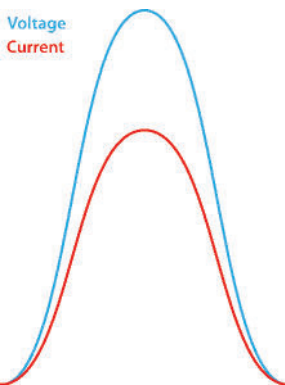

Figure 2

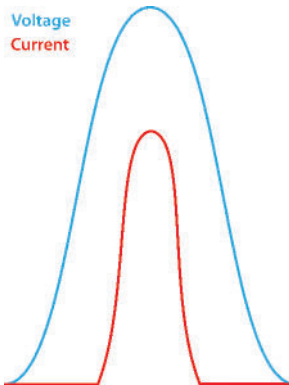

Figure 3

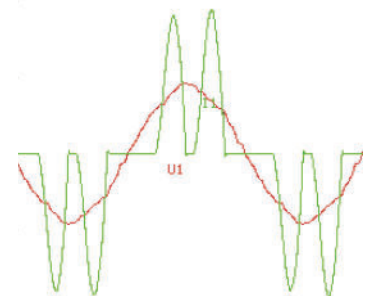

Figure 4: Nonlinear input current of a six-pulse VFD: red = line voltage, green = current

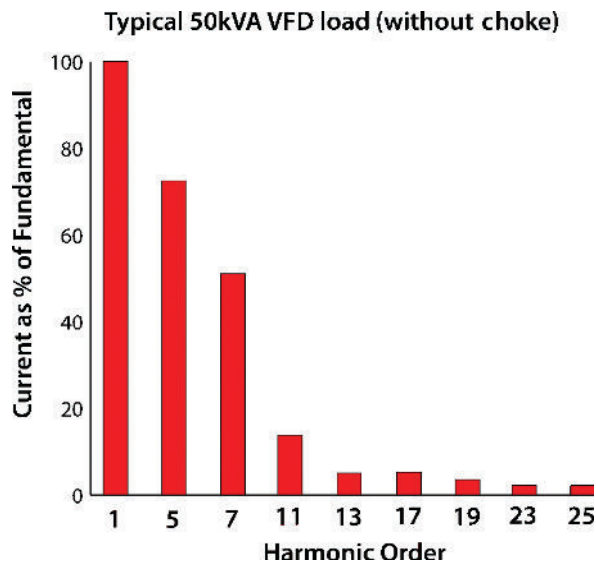

Figure 5: Current harmonics of six-pulse drive.^[1]

Using the equation, a six-pulse drive would draw current harmonics located at the fifth, seventh, 11th, 13th, etc. orders. The magnitude of the current harmonics decays at higher orders, with the most significant harmonics in a six-pulse drive being found at the fifth and seventh orders.

Harmonics

According to the Institute of Electrical and Electronics Engineers (IEEE), harmonics are defined as “a sinusoidal component of a periodic wave or quantity having a frequency that is an integral multiple of the fundamental frequency.” For North American installations, the harmonics of a 60-Hz utility power supply would include the frequencies listed in Table 2.

The primary current component is called the fundamental, which is at the line frequency. Each harmonic current is at a specific frequency *n* times the line frequency and has a magnitude dependent on the load. The sum of these create the complete current flowing into the load. Only the fundamental current component creates usable work on the output of the equipment. The other harmonic components are classified as reactive power and create no usable work.

Harmonic	Frequency (Hz)
0	0 (DC)
First (fundamental)	60
Second	120
Third	180
Fifth	300
...	...
40th	2,400

Table 2

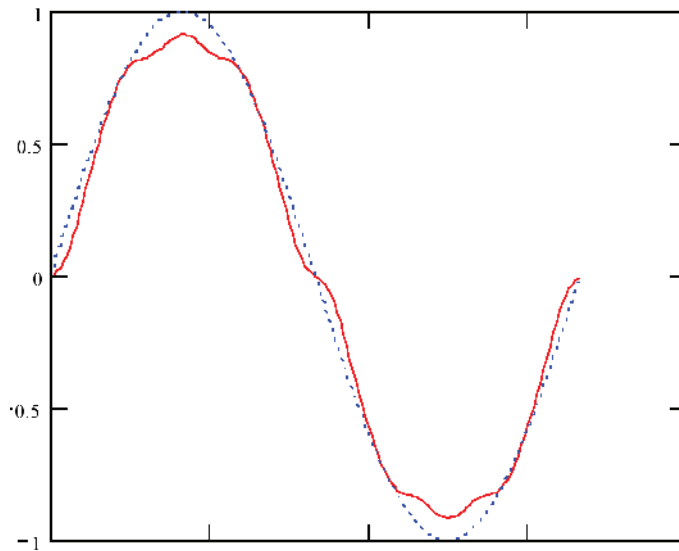

Figure 6: Voltage distortion example: blue = line voltage at service entrance to building, red = distorted line voltage within the building

$$I_{rms} = I_{Fundamental} + \sum_{n=2}^{\infty} I_n \quad \text{Equation 1}$$

Each of the current components interacts with the voltage source through the impedances of the electric system. Since some of the impedances are common to multiple loads in the facility, the influence is then shared across the loads. In this way, the supply voltage of the other loads becomes distorted by the equipment in question.

Figure 6 shows how adding two harmonic components at the fifth and seventh can potentially distort the voltage on the electrical system.

Power Factor

Power factor is also sometimes used to refer to the amount of harmonics in a system. The power factor represents the ratio between the power being put into useful work (active power) at the fundamental frequency and the total electrical power being transferred. A unity power factor (1.00) is desired and indicates that all power transferred is being usefully consumed by the load. A low power factor is avoided, because it requires electrical components to be oversized to accommodate the transfer of unused reactive and/or harmonic power.

The IEEE 519 standard describes two components that make up the total power factor – the displacement factor and the distortion factor.

$$PF_{Total} = PF_{Displacement} \times PF_{Distortion} \quad \text{Equation 2}$$

The $PF_{Displacement}$ is the ratio of the used active power (measured in watts) and the reactive power (measured in V/amps) at the fundamental frequency. The displacement factor is affected by the impedance of the load and calculated by measuring the phase shift (Equation 3) between

Continued

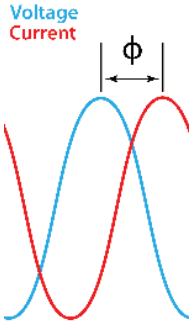

Figure 7 (left): Displacement power factor

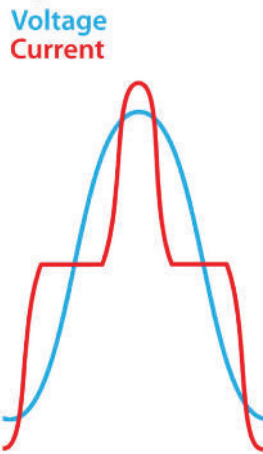

Figure 8 (right): Distortion power factor: current is in phase with voltage but distorted

the applied voltage and load current. A six-pulse VFD will have a relatively high $PF_{\text{Displacement}}$ usually greater than 0.9.

$$PF_{\text{Displacement}} = \cos(\phi) \quad \text{Equation 3}$$

$PF_{\text{Distortion}}$ is the component of power factor affected by harmonics. It represents the ratio between the rms current at the fundamental frequency and the total rms current at all frequencies.

$$PF_{\text{Distortion}} = I_{\text{fundamental, rms}} / I_{\text{rms}} \quad \text{Equation 4}$$

IEEE 519-1992 Standard

The IEEE 519-1992 standard, titled “IEEE Recommended Practices and Requirements for Harmonic Control in Electrical Power Systems,” developed from a need to define and measure acceptable system-level voltage and current harmonics. The utility company is responsible for providing its customers with clean sinusoidal voltage with low distortion. In turn, the customers have a responsibility to not create too many current harmonics and, thus, cause undesirable voltage distortion for other customers. The IEEE 519 standard provides a basis for measuring harmonics and defines acceptable harmonic levels.

PCC

As specified in the IEEE 519 standard, the point where the utility’s electric system and the consumer’s system come together is defined as the point of common coupling (PCC). Literally, it is the first point at which the electric system is distributed within the consumer’s facility; typically the facility’s main feeder panel. The PCC is where all the loads within the consumer’s system come together to present a unified load to the utility. This is important because some of the consumer’s loads may actually compensate or negate the lower power factor or high harmonics of other loads. As a result, the utility sees an aggregate of all consumer loads at the PCC. The distortion

of the collective load measured at the PCC is often better than the distortion of any one individual nonlinear load.

That being said, the degree to which a load impacts the utility depends largely on the relative size and duty of that load. For example, a single 200-hp, VFD-driven chiller running at continuous duty will have a much greater impact on the building’s electric system and utility load than a 40-hp elevator system operating at 50% duty, at best. The harmonic currents from the chiller VFD alone could exceed the total current drawn from the elevator VFD, making the elevator load somewhat inconsequential.

However, since the facility’s main feeder panel is often hard to access by equipment contractors, a general practice has been adopted to apply the terms and conditions of the IEEE 519 standard to the local accessible electrical system. This is typically the disconnect switch feeding the equipment in question. So, in practice, the PCC becomes the disconnect switch for the chiller system. Likewise, the disconnect for the elevator system is the PCC for the elevator control supplier and contractor. While this is not technically correct according to the standard (and, further, the utility would never make such a measurement), it is the accepted practice. The theory is that if the power quality at the equipment disconnect is in compliance, then the equipment can in no way negatively effect the power quality within the building.

THD Versus TDD

While the calculation method is similar, total harmonic distortion (THD) and total demand distortion (TDD) can result in significantly different numerical results. The following definitions are taken directly from the IEEE 519-1992 standard.

THD is calculated as the ratio of the root-mean-square of the harmonic content to the root-mean-square value of the fundamental quantity, expressed as a percent of the fundamental. To be clear, this is an instantaneous value.

$$THiD = \sqrt{\frac{\sum_{n=2}^{\infty} I_n^2}{I_{\text{Fundamental}}^2}} \times 100\% \quad \text{Equation 5}$$

TDD is calculated as the total root-sum-square harmonic current distortion, in percent of the maximum demand load current (15- or 30-min. demand). This method is time dependent in that the value of the fundamental current is determined over time, and an average of this value is used as the point of reference for the calculation. This creates a more accurate picture of what the so-called nominal current value really is. Current harmonics are then compared to this long-term average value, providing a more accurate view on the impact to the system. This is the reason for its use in determining the limit values set forth in the IEEE-519 standard.

$$TDD = \frac{\sqrt{\sum_{n=2}^{\infty} I_n^2}}{I_{Max.Demand.Load}^2} \times 100\% \quad \text{Equation 6}$$

The maximum demand fundamental current is an average of all fundamental load currents present at the PCC. When there is only one load connected at the PCC, as in the case of a singular equipment evaluation (i.e., one elevator), this current becomes the average current into this load. This tends to complicate the measurement and subsequent calculation, because the elevator does not operate continuously. The average current is much less than the instantaneous value. The resulting calculated distortion value at any given moment can then be influenced by the loading and number of operations of the elevator over time. To overcome this issue, it has become commonplace to measure the current and calculate the THD value while the elevator is running up at full load. This would be the point of pseudo maximum current draw from the electric system and, therefore, the point that could create the greatest influence on other loads within the facility.

Effects of Electrical System Impedance

The impedance of the electrical system supplying the PCC has an influence on the distortion value. Higher system impedances generally result in systems that are more easily distorted by a given nonlinear load. This is taken into account by the IEEE 519 standard by establishing the distortion limits based on a ratio of the available short-circuit current to the average load current, I_{sc}/I_L . As the system impedance becomes lower, the ratio becomes higher; therefore, the allowed distortion level is increased. The levels are defined as follows:

I_{sc}/I_L	TDD
<20	5%
20<50	8%
50<100	12%
100<1,000	15%
>1,000	20%

Table 3

The following examples establish a few points of reference for the I_{sc}/I_L ratios.

Example 1

Assume each elevator is fed from an individual isolation transformer that is on the line side of the PCC. The transformer is sized based on the VA of the elevator motor (where transformer VA = $FLA_{motor} \times Volts_{motor} \times 1.73$). If the transformer has impedance around 5%, the resulting I_{sc}/I_L will be around 20. Acceptable TDD values would be 5% if

the ratio is below 20 and 8% if at or above 20. Note, this would be considered a minimum sizing for the transformer, and the configuration would not typically be employed.

Normally, the input full load amps (FLA) to the controller would be considered when sizing the transformer, which would push the VA of the transformer higher. The result is that the I_{sc}/I_L ratio would rise to approximately 25-30, and the acceptable TDD value would be 8%.

Example 2

Assume a bank of four elevators is fed from a distribution transformer and the transformer is on the line side of the PCC. The transformer is sized based on the collective load of all four elevator controls. If the transformer has an impedance of 5.5%, the resulting I_{sc}/I_L will be around 75, with the acceptable TDD being 12%.

Example 3

Assume the elevator is fed directly from the facility's mainline without a transformer. The building has a main feeder transformer of 800 kVA with an impedance of 6.7%. The elevator controller is sized to operate a 40-hp induction motor (standard 350 fpm and 3,500 lbs.). The resulting I_{sc}/I_L would be around 266, and an acceptable TDD would be 15%.

In general, higher transformer impedance lowers the I_{sc}/I_L ratio, while oversizing the transformer raises the ratio. Based on these examples, it can be established that in most cases, the typical elevator installation will have the I_{sc}/I_L ratio falling in the range of 20-500. This means that the target TDD value based on the IEEE 519 standard will be in the range of 8-15%.

Advanced Elevator Drive Topologies

Regenerative Drive

During a typical elevator cycle, energy is put into the system, stored and returned. During motoring mode, energy flows from the utility to the motor and mechanical work is done when the elevator cab moves. Additionally, both potential and kinetic energy are stored in the elevator system and returned to the drive during generating mode. Since the current cannot flow across the input rectifiers, the regenerative energy is stored in the DC bus capacitors.

Traditionally, braking resistors have been used to rid the capacitors of the excess regenerated energy. As current flows into the capacitors, the voltage across the capacitors increases. When the DC bus voltage reaches a threshold, a resistor circuit is closed across the capacitors, and current flows through the braking resistor, dissipating the excess electrical energy as heat. The heat represents energy loss in the system, since it cannot be recovered. Braking resistors are twice as inefficient when additional energy is needed to power an air-conditioning unit to cool the control room.

Continued

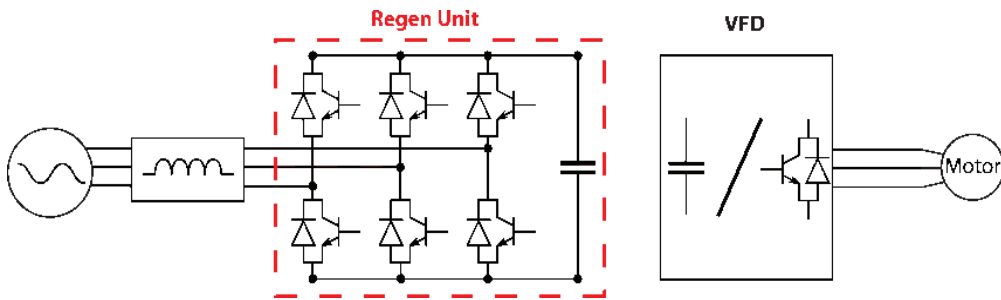

Figure 9: Basic wiring topology of a DC-bus-connected regen drive and VFD

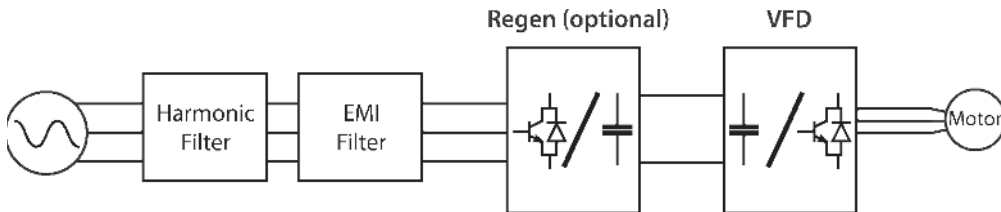

Figure 11: Harmonic filter with variable-frequency drive and optional power regeneration

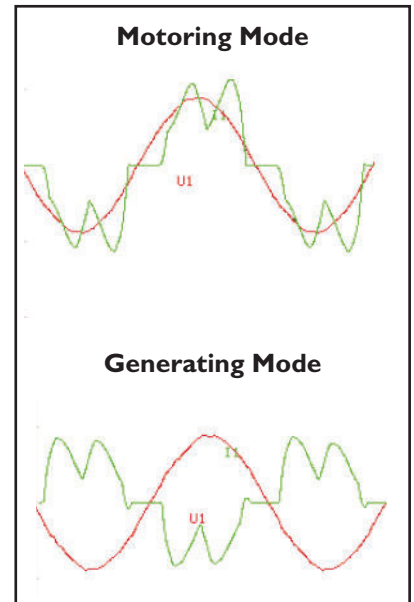

Figure 10: Voltage and current of a regen system: red = line voltage, green = current

A regenerative unit can be used in lieu of a braking resistor, and the regenerated power can be returned to the grid, where it is consumed by other building loads. Regen units are becoming increasingly popular, as they can dramatically increase system efficiency and lower the total cost of elevator ownership.

The components of regen drives are similar to those of a six-pulse VFD, except there is no input diode stage. The regen drive has DC bus capacitors and an IGBT stage used to output current into the mainline. Additionally, an inductor is used to smooth current flow and synchronize the current to the voltage and frequency of the mainline.

When the voltage of the coupled DC bus reaches a threshold, the regen unit's IGBTs cycle at the same frequency of the line and current flows back onto the line. It should be noted that since the regen unit's IGBT's only cycle at 60 Hz, there are significantly less switching losses during operation than the PWM operation of a VFD. Since the regen's IGBTs switch the current into the line in a similar manner to the diodes in a six-pulse rectifier, a regen unit will have similar harmonic content during regen mode as a VFD.

Passive Harmonic Filtering

A series of low-pass harmonic filters can be placed at the input of a VFD or regen unit to reduce the harmonic currents. The harmonic filter is composed of inductors and capacitors and designed such that the filter passes current at the fundamental frequency but blocks current at higher frequencies. For example, KEB's patented harmonic filters have been designed to filter and cancel the fifth, seventh, 11th, 13th, 17th, and 19th harmonics with a target of achieving less than 8% total harmonic current distortion (THiD) at rated load. Because the filter operates in both directions of current flow to and from the building's electric system, it can be used with regen units

KEB Harmonic Filter

With the harmonic filter, the power factor (PF_{Total}) is typically 0.99 to 1.00. Harmonic filters are robust because of their passive design and help protect the VFD and regen unit from line side disturbances or transients. They exceed the performance of an isolation transformer, making the transformer unnecessary in cases where the controller can operate direct from the building voltage. Further, with a harmonic filter installed, the capacitors in the DC bus of the VFD and regen unit see much lower ripple current, resulting in less heating and a dramatic increase (up to three times) in lifespan.

It should be noted that the harmonic filter does introduce additional resistive losses to the system. However, these losses are small in relation to the energy returned by the regen unit. Also, when the VFD is idle, the filter presents a slight capacitive load to the electric system. However, if desired, this capacitive load can be switched out. Filters can be designed with different topologies to block different harmonic orders. Therefore, the performance can vary considerably from filter to filter. In some cases, if the filter is not designed to handle abnormal operation or system resonance, the filter can actually damage the VFD. So, it is im-

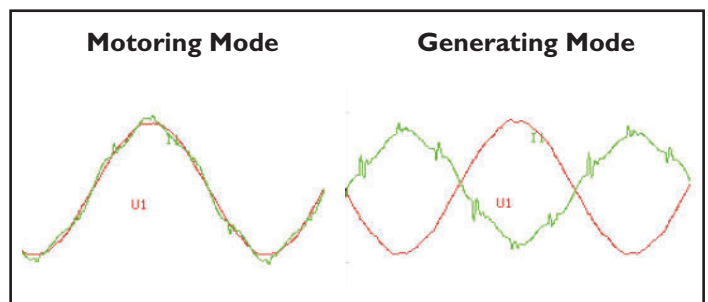

Figure 12: Voltage and current of regen system with harmonic filter: red = line voltage, green = current



Figure 13: KEB harmonic filter

portant to ensure the filter has been matched with the drive and regen unit and approved for bidirectional power flow.

Active Front End

The active front end (AFE) system is comprised of two back-to-back inverters. The first inverter synchronizes itself to the line voltage and actively rectifies the AC voltage into DC. This active rectifier stage uses an inductive capacitive filter to link to the AC line. The result is current flowing from the line in a nearly pure sine wave with low harmonic distortion; in many cases, it can be below 3% THiD. The PF_{Total} is regulated to a value of 1.00. Additionally, a high-quality EMI filter in front of the system is necessary, as the active rectifier creates a high level of common-mode EMI relative to earth ground. The second inverter functions as a motor drive and controls the motor as before, independent of the front-end stage.

Because the AFE uses PWM with a high-carrier frequency, the switching losses are higher compared to the block-style commutation of the regen unit. The PWM iron losses in the AFE filter are also higher compared to those in similarly sized harmonic filters. AFE systems can only be connected to a balanced three-phase wye, center grounded electric system; delta-connected systems are not permissible. Additionally, the phase voltages should be +/-5% with respect to each other. A transformer must be used in buildings having an older delta electric system or if the phases are greatly unbalanced. An AFE exceeds the requirements of the IEEE 519 standard, but the added performance comes at a higher cost.

Cost/Benefit Analysis

Six-Pulse VFD

A six-pulse VFD is the most cost effective AC drive solution and should be considered for all traction applications. In smaller applications (<30 hp), a standard VFD

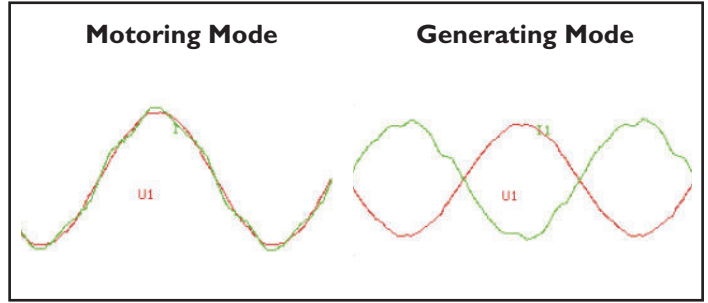

Figure 15: Voltage and current of active front end: red = line voltage, green = current

will contribute relatively little harmonic distortion on a facility's electrical system, so additional low-harmonic solutions are likely not economical. Again, the advantages of the six-pulse VFD are its simplicity, reliability and energy savings through improved control.

Input Reactor (with VFD)

Using an input reactor or choke at the input of the VFD is strongly recommended in every VFD application. An input reactor is a relatively modest investment and will dramatically improve the VFD's harmonic distortion. Using an input reactor will lower the THiD value of a six-pulse VFD from about 80% to 45%. An input reactor also has the additional benefit of reducing the peak currents into the rectifiers and DC bus capacitors. As a result, the DC bus capacitor's operating lifetime is usually doubled when using an input reactor. Note that a drive isolation transformer will also achieve the same result but the transformer is eight to 10 times the cost of a choke.

Regen Drive

Applications using a regen drive should be selected carefully to ensure reasonable payback. Due to their high efficiency, *all* applications using gearless permanent-magnet motors should be considered. High-duty installations where elevators run 24/7 are great candidates for regen units – potential installations include hospitals, hotels and airports. High speed (>500 fpm) and high capacity (>3,000 lbs.) should also be strongly considered, as the large moving mass at high speeds provides significant energy returns – these installations include freight cars, office buildings, etc. Low-speed, low-capacity and inefficient worm geared applications will not regenerate a lot of energy, so the regen unit provides little value in these cases.

Typically, the addition of a regen unit offers the quickest ROI and provides the greatest increase to the operating

Continued

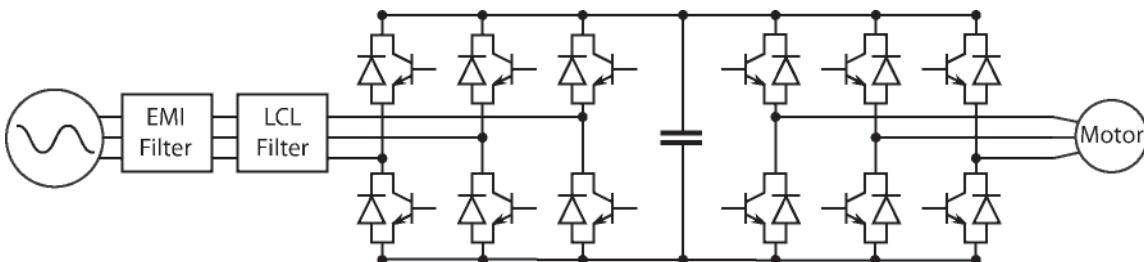

Figure 14: AFE

efficiency of the elevator system. Even existing elevators operating with a VFD can be easily upgraded with a standalone regen unit (e.g., a small control box that mounts outside the main panel). Most utilities will give offsetting rebates or credits based on the upgrade to or installation of a regen unit. Since a regen unit does contribute harmonics during regen operation, some harmonic mitigation through filters might be considered in certain applications. However, energy audits have shown that elevators account for a relatively low amount of a building's energy consumption – around 3-5% of the building total.^[3] This is significant, because it means there are other building loads, like the HVAC or lighting systems, which potentially contribute far more harmonics to the building's electric system than the elevator could.

Passive Series Harmonic Filter (with VFD and/or Regen)

A harmonic filter provides excellent harmonic mitigation performance at an affordable price and should be considered whenever there is a requirement to meet the IEEE 519 standard. The filter can usually be housed in the

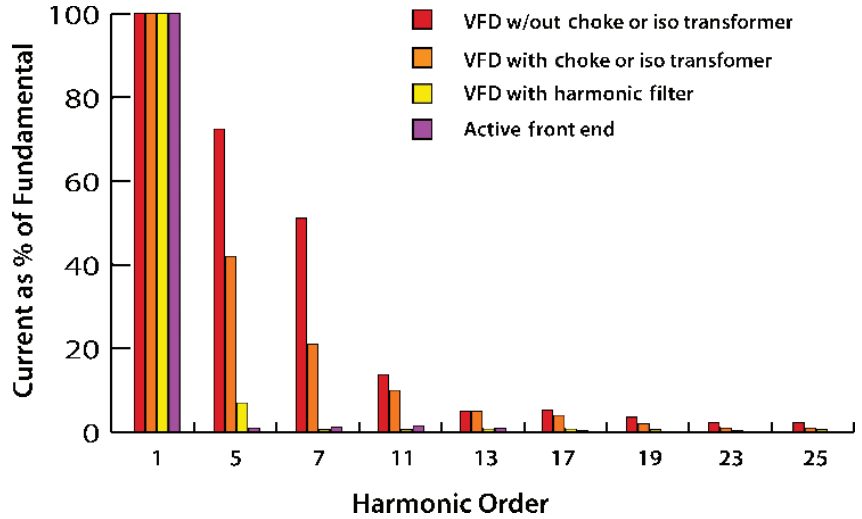

Figure 16: Typical VFD harmonic performance

elevator control cabinet, so it does not require a separate enclosure – this helps to lower the initial cost and is a good solution for smaller motor rooms. The filter completely eliminates the need for an isolation transformer when the controller and building voltage are the same. In this case, the cost savings of this transformer negate the additional cost of the filter. Because the filter is passive, it does not require separate electronics to be controlled. Ultimately, this provides for a more robust system.

AFE

An AFE provides the best harmonic performance and is inherently capable of regenerating power back to the line. However, the AFE has significantly more components and requires a more sophisticated control scheme than the other solutions. Furthermore, this type of system is physically larger than a similar drive/regen/filter combination. However, as the relative power level increases, the AFE solution becomes more in line with the filter/regen solution in both cost and size.

The high upfront cost and size of an AFE elevator drive limit its usefulness to only higher power (>50-hp) installa-

Drive topology	PF _{Total}	THiD	Initial cost
AC VFD	0.95	60-80%	\$
AC VFD w/choke	0.96	45%	\$+
Regen (w/AC VFD & choke)	0.96	45%	\$\$
AC VFD (w/regen & choke) and isolation transformer	0.96	45%	\$\$\$
Harmonic filter (w/AC VFD & Regen)	0.99-1.00	8%	\$\$\$
AC VFD with AFE (active front end)	1.00	3 to 5%	\$\$\$\$

Table 4: Drive harmonic performance vs. cost

tions, where costs are already high due to the speed or capacity of the elevator. Certain installations (i.e., data centers, hospitals and airports) with strict power quality requirements will also be likely candidates for AFE elevator drives.

Conclusion

When it comes to harmonic mitigation, nothing is free. The extra components required to mitigate drive harmonics require more packaging and add upfront cost to the elevator controller. However, payback can ultimately be realized in the form of smaller electrical components, regenerative energy, utility rebates and increased operating lifetime of other system components.

The IEEE 519 standard is meant as a guideline and provides goals for acceptable power quality. It is not economical or feasible that every elevator meet these requirements, as other loads within the building will have a dominating effect. In the end, a building owner or consultant will need to weigh the different drive technologies and paybacks to see if the added investment of regen drives and harmonic mitigation justifies the benefits.

References

- [1] *IEEE Recommended Practices and Requirements for Harmonic Control in Electrical Power Systems*, IEEE Standard 519, 1992.
- [2] *Harmonic Limit Compliance Evaluations Using IEEE 519-1992*, S. Mark Halpin 1 and Reuben F. Burch, IV2
- [3] ISR-University of Coimbra. "Energy Efficient Elevators and Escalators." Internet: www.e4project.eu, March 2010. [October 3, 2010].

Jonathan Bullick is a sales engineer in the Elevator Applications Group at KEB America, Inc. For the past six years, he has worked in the application of brakes and motor controls. He graduated from the University of Minnesota, Twin Cities with a BS in Electrical Engineering, where he is currently completing an MBA.

Brad Wilkinson is vice president of Engineering at KEB America, Inc. He has 20 years of experience in the design and application of AC drive technology in a variety of application areas, one being elevators. He graduated from the University of Minnesota, Twin Cities with a BS in Electrical Engineering.

Learning Reinforcement Questions

- ◆ What is a nonlinear load, and how does it cause voltage distortion?
- ◆ What is total power factor, and how is it related to current harmonics?
- ◆ How is the system voltage distorted by current harmonics?
- ◆ What different methods are used to reduce current harmonics?
- ◆ How do the relative sizes of the utility system and elevator VFD affect how much voltage distortion is created?



ELEVATOR WORLD Continuing Education Assessment Examination Questions

Instructions:

- ◆ Read the article **“Elevator Drives, Power Quality and Energy Savings”** (page 62) and study the learning-reinforcement questions.
- ◆ To receive **one hour (0.1 CEU)** of continuing-education credit, answer the assessment examination questions found below online at www.elevatorbooks.com or fill out the ELEVATOR WORLD Continuing Education Reporting Form found over-leaf and submit by mail with payment.
- ◆ Approved for Continuing Education by **NAEC for CET® and NAESA International and QEI Services, Inc. for QEI.**

1. A six-pulse VFD is most commonly applied in traction elevator applications because it:
 - a. Is reliable and robust.
 - b. Is a cost-effective solution.
 - c. Allows for precise motor control.
 - d. All of the above.
2. The input stage of a six-pulse VFD, which converts AC power into DC power, is made up of:
 - a. Resistors.
 - b. Rectifiers.
 - c. Transistors.
 - d. Capacitors.
3. Voltage distortion causes:
 - a. Increased rms current.
 - b. Interference of sensitive electrical equipment.
 - c. Increased heating in electrical components.
 - d. All of the above.
4. Total Current Harmonic Distortion (THiD) is:
 - a. A measurement of instantaneous current harmonics.
 - b. The system impedance of the utility at the PCC.
 - c. The available short-circuit current.
 - d. A measurement of time-averaged current harmonics.
5. Nonlinear loads, which create the largest voltage distortion, will:
 - a. Operate seldomly.
 - b. Operate at partial duty.
 - c. Operate at continuous duty.
 - d. All of the above.
6. Using a choke at the input of the drive:
 - a. Increases the operating lifetime of the rectifiers.
 - b. Increases the operating lifetime of the capacitors.
 - c. Reduces the drive's harmonic current draw.
 - d. All of the above.
7. The higher the electrical system's I_{sc}/I_L ratio, the:
 - a. Less distortion is permitted at the PCC.
 - b. More distortion is permitted at the PCC.
 - c. More a VFD will affect the quality of the utility power.
 - d. None of the above.
8. A good candidate for applying regen elevator applications is:
 - a. An MRL gearless.
 - b. A hospital elevator that runs at a very high duty every day.
 - c. A freight car moving a large amount of mass at high speeds.
 - d. All of the above.
9. Typically, which regen technology provides the quickest return on investment?
 - a. Active front end.
 - b. Regen with harmonic filter.
 - c. Basic regen unit.
 - d. All of the above.
10. During operation, which technology provides the lowest current harmonics?
 - a. VFD.
 - b. Regen.
 - c. VFD with harmonic filter.
 - d. Active front end.



ELEVATOR WORLD Continuing Education Reporting Form



Article title: **“Elevator Drives, Power Quality and Energy Savings”** (EW, December 2011, page 62).

Continuing-education credit: This article will earn you **one contact hour (0.1 CEU)** of elevator-industry continuing-education credit.

Directions: Select one answer for each question in the exam. Completely circle the appropriate letter. A minimum score of 80% is required to earn credit. You can also take this test online at website: www.elevatorbooks.com.

Last name: _____

First name: _____ Middle initial: _____

CET®, CAT® or QEI number: _____

State License number: _____

Company name: _____

Address: _____ City: _____

State: _____ ZIP code: _____

Telephone: _____ Fax: _____

E-mail: _____

This article, **“Elevator Drives, Power Quality and Energy Savings,”** is rated for one contact hour of continuing-education credit. Certification regulations require that we verify actual study time with all program participants. Please answer the below question.

How many hours did you spend reading the article and studying the learning-reinforcement questions?
hours _____ minutes _____

Circle correct answer

- | | | | | | | | |
|------|---|---|---|-------|---|---|---|
| 1. a | b | c | d | 6. a | b | c | d |
| 2. a | b | c | d | 7. a | b | c | d |
| 3. a | b | c | d | 8. a | b | c | d |
| 4. a | b | c | d | 9. a | b | c | d |
| 5. a | b | c | d | 10. a | b | c | d |

Signature: _____

Payment options:

- Check one: \$30.00 – Non-subscriber course fee
 \$25.50 – ELEVATOR WORLD subscriber course fee
 Subscriber #: _____
 (6 digit number on your print label or in your digital confirmation.)
 Payment enclosed
 (check payable to Elevator World, Inc.)

- Charge to my: VISA
 MasterCard
 American Express

Card number: _____

Expiration date: _____

Signature: _____

To receive your certificate of completion using the mail-in option, send the completed form with questions answered and payment information included to: Elevator World, Inc., P.O. Box 6507, Mobile, AL 36660.

To receive your certificate of completion online, visit website: www.elevatorbooks.com and follow the instructions provided for online testing.

You now have the opportunity to earn Continuing Education contact hours in ELEVATOR WORLD magazine. Articles pertain to various industry topics that appear in the magazine bi-monthly, and for every exam you successfully complete, you'll earn 1–3 contact hours.

As a subscriber, you not only have full access to these Continuing Education articles, but you also receive 15% off of the retail price.

Your subscription & all Online Continuing Education Courses can be purchased at

elevatorbooks.com

ELEVATOR WORLD'S ONLINE BOOKSTORE

Your Subscription to
ELEVATOR WORLD
has just become more valuable.

